

## SolarMax Energy Systems

# Djibouti energy storage system investment



## Overview

---

This 60 MW facility, developed by Red Sea Power Limited SAS, has significantly boosted the nation's energy capacity by 50%. The project, costing US\$122 million, is expected to reduce CO<sub>2</sub> emissions by 252,500 tonnes annually, equating to the pollution from over 55,000 buses.

## Djibouti energy storage system investment

---



### ENERGY STORAGE LITHIUM BATTERY DJIBOUTI INVESTMENT

Main business lithium battery energy storage system Global demand for Li-ion batteries is expected to soar over the next decade, with the number of GWh required increasing from ...

[Get a quote](#)

### Djibouti Photovoltaic Energy Storage Power Station A Blueprint ...

This article explores its technical innovations, economic impact, and role in addressing regional energy challenges while aligning with global sustainability goals.

[Get a quote](#)



### energy storage investment trends djibouti

MITEI's three-year Future of Energy Storage study explored the role that energy storage can play in fighting climate change and in the global adoption of clean energy grids. ...

[Get a quote](#)



## djibouti energy storage for renewable energy

This section investigates energy consumption and the economic costs of hydrogen as an energy storage solution for renewable energy in ASEAN and East Asian countries.

[Get a quote](#)

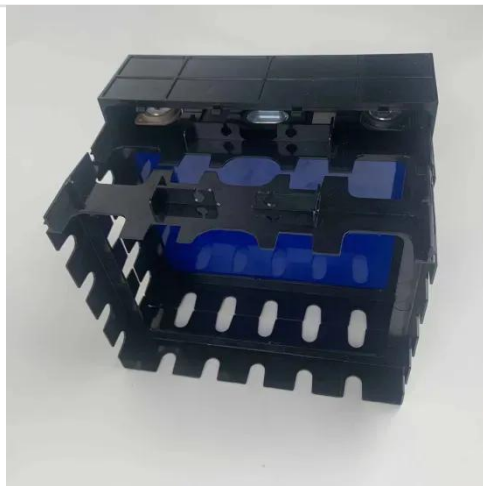

## Everything to Know About Renewable Energy in Djibouti

The plant includes battery storage systems to ensure an uninterrupted supply and has already started providing clean power to underserved rural areas. Indeed, full completion ...

[Get a quote](#)

## New Energy Storage Power Station in Djibouti Powering ...

This article explores the project's significance, technological innovations, and its alignment with global sustainability trends - while highlighting opportunities for international collaboration in ...

[Get a quote](#)

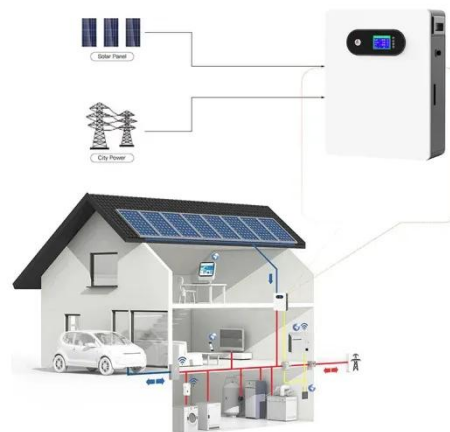

## Djibouti energy storage electricity price subsidy policy

The Office of Electricity's (OE) Energy Storage Division accelerates bi-

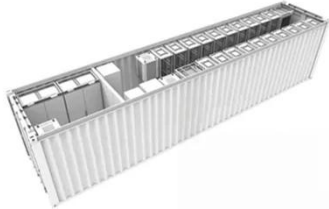

directional electrical energy storage technologies as a key component of the future-ready grid.

[Get a quote](#)

## home energy storage djibouti city

Djibouti 60kW/240kWh Zhejiang HIITIO New Energy Co., Ltd. Head Office Hiitio specializes in producing high-voltage DC electrical devices for EV, solar energy systems, and energy ...

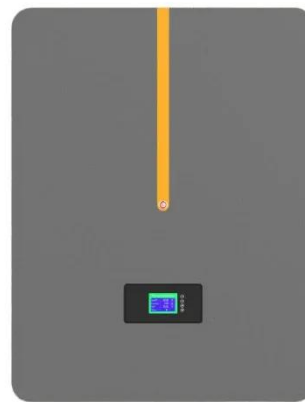

[Get a quote](#)



## Djibouti energy storage solar power generation maintenance

JSW Energy wins 700MW solar capacity from SECI in India The company has also made significant strides in energy storage, securing 3.4 gigawatt-hours (GWh) of capacity through ...

[Get a quote](#)

## Djibouti's Path to Sustainable Energy Success

Currently, FSD has investments in data centers, renewable energy, and logistics, with a pipeline worth over \$50 million.

International partnerships play a crucial role in Djibouti's energy transition.

[Get a quote](#)

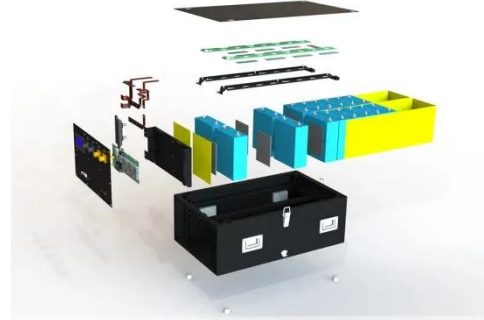

## Renewable Energy Integration in Djibouti: Challenges, ...

Using academic sources and case studies, we analyze the technical and economic feasibility of renewable energy projects in Djibouti and provide recommendations for ...

[Get a quote](#)

## Djibouti Modern Energy Storage Production Base Project

A \$1.6bn project to build a pipeline to transport refined energy products between Djibouti's import facilities and Ethiopia, announced in 2015, was shelved by the Ethiopian

[Get a quote](#)



## Djibouti Energy Storage System Market (2025-2031) , Trends, ...

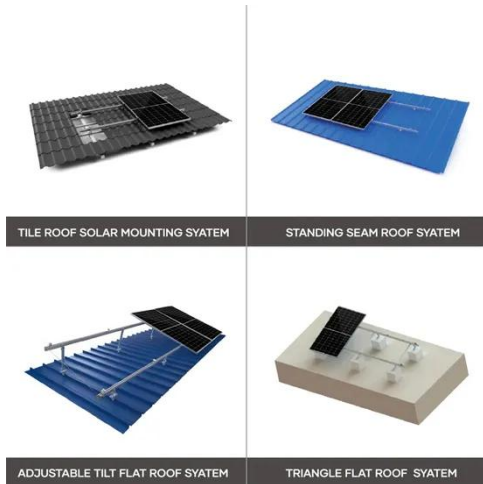

Market Forecast By Technology (Pumped Hydro Storage, Battery Energy Storage, Compressed Air Energy Storage, Flywheel Energy Storage), By Application (Stationary, Transport), By End ...

[Get a quote](#)

## djibouti energy storage for renewable energy

Djibouti redesigns energy systems to increase power generation. Developing renewable energy can help to build resilience to volatile prices and lower energy costs. Power Drive In addition to ...



[Get a quote](#)



## Djibouti Lithium-Ion Battery Energy Storage System Market (2025 ...

Historical Data and Forecast of Djibouti Lithium-Ion Battery Energy Storage System Market Revenues & Volume By Residential Energy Storage Systems for the Period 2021-2031

[Get a quote](#)

## Wind energy storage Djibouti

Djibouti inaugurates its first ever wind farm. Investment in renewable energy

infrastructure is the key to enabling our ambitions, and the inauguration of the groundbreaking Red Sea Power ...

[Get a quote](#)

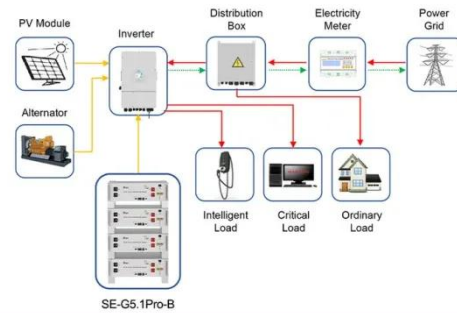

Application scenarios of energy storage battery products



## Djibouti Energy Storage Solutions Market (2025-2031)

Djibouti Energy Storage Solutions Industry Life Cycle Historical Data and Forecast of Djibouti Energy Storage Solutions Market Revenues & Volume By Type for the Period 2021-2031

[Get a quote](#)

## Latest Djibouti grid energy storage policy

Residential Solar Storage Systems Our Residential Solar Storage Systems are designed to provide homeowners with a reliable and efficient way to store excess solar energy, reducing ...

[Get a quote](#)



## How does the Djibouti energy storage field make money

Our range of products is designed to meet the diverse needs of base station energy storage. From high-capacity



lithium-ion batteries to advanced energy management systems, each ...

[Get a quote](#)



## Potise Unveils Comprehensive 2025 Guide to Battery Energy Storage

6 hours ago · What is a Battery Energy Storage System (BESS) and why is it crucial in 2025? BESS technology is revolutionizing how we generate, store, and use energy, helping ...

[Get a quote](#)



## Contact Us

For catalog requests, pricing, or partnerships, please visit:  
<https://zenius.co.za>